

E.X.PZ.A0V
E.A.PZ.A0V

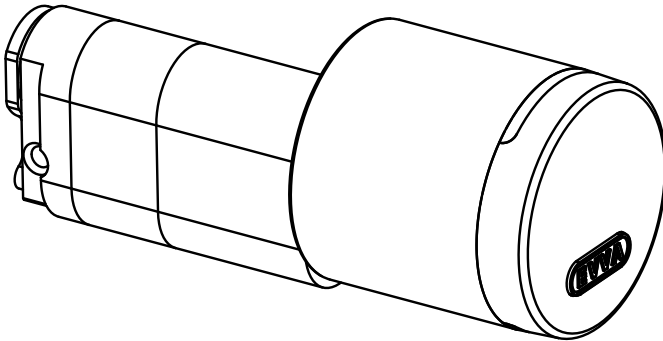

Xesar & AirKey

Montageanleitung | Assembly manual | Montagehandleiding
Instructions de montage | Istruzioni di montaggio | Montážní návody
Montážne návody | Instrukcje montażu | Installationsanvisningar

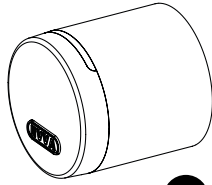

1x

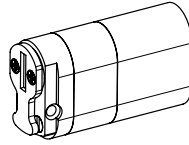

1x



1x

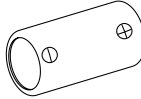

2x

CR2



1x

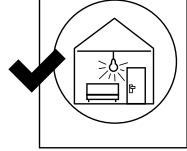
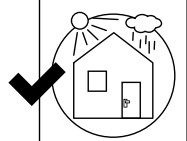

cam supplied
by reseller



PH0 + PH2

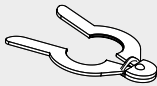

E.ZU.PZ.ZW01



E.X.IM.CC

E.A.IM.SH.J80K+D08K



E.A.IM.KA.J80K+D08K



NEW

FZG

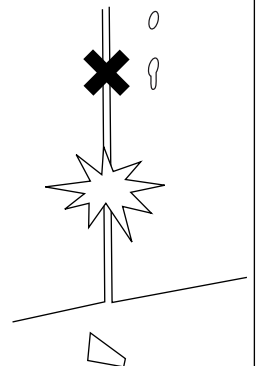
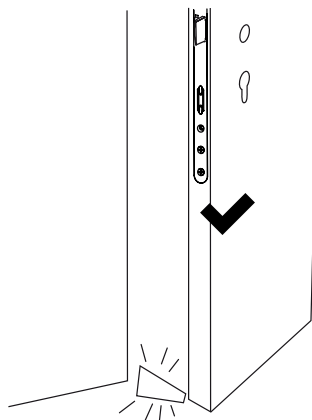
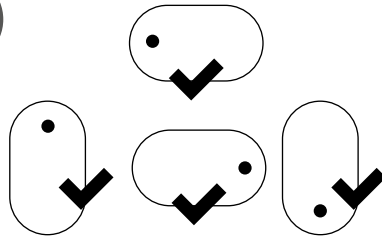

1

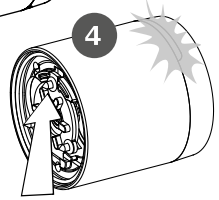
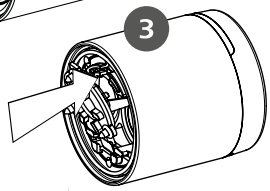
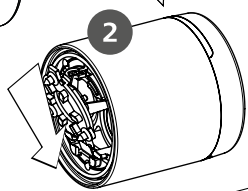
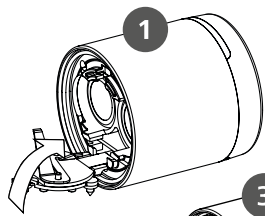
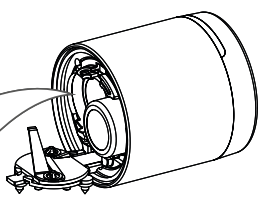
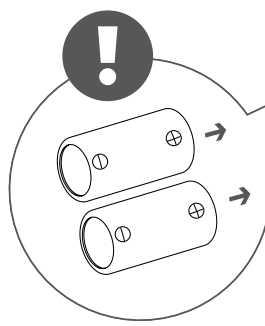
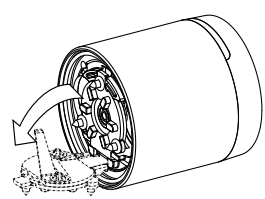
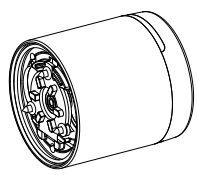
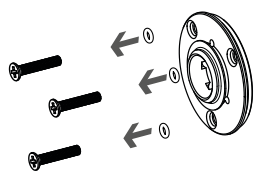
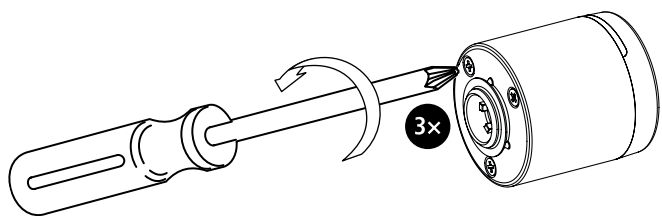

IP65 ✓

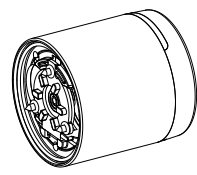
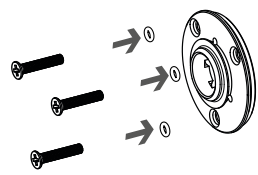

0,5 Nm

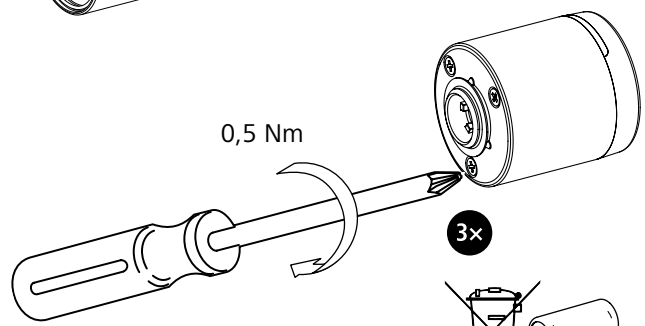

3x

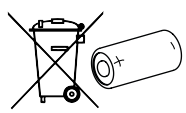
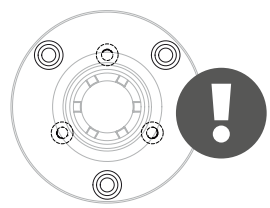

2

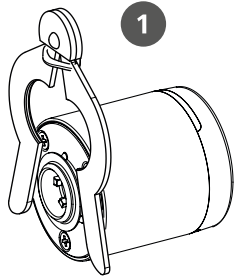

1

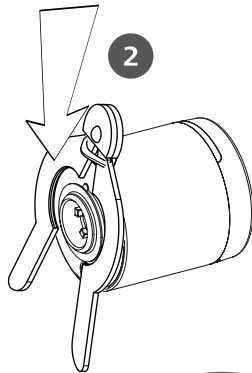

2

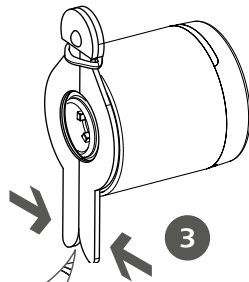

3

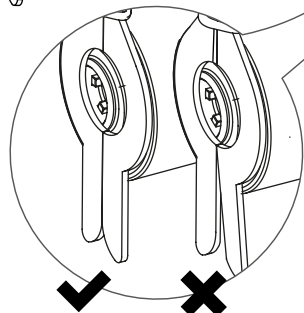

IP65



3

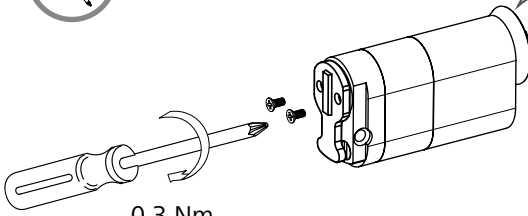

0,3 Nm

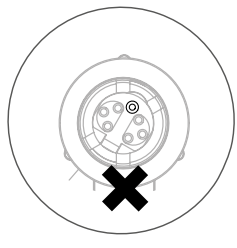
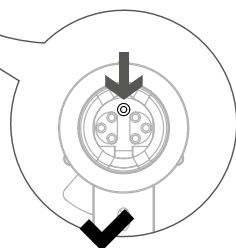
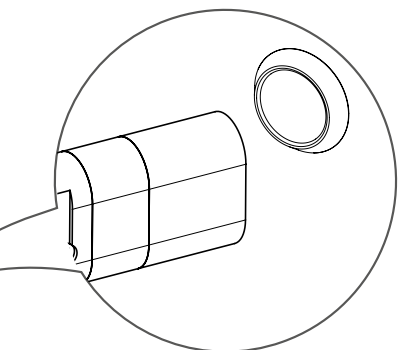

4

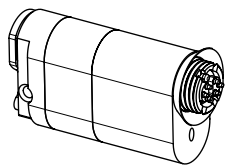

1

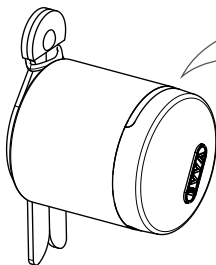

60°



2

!

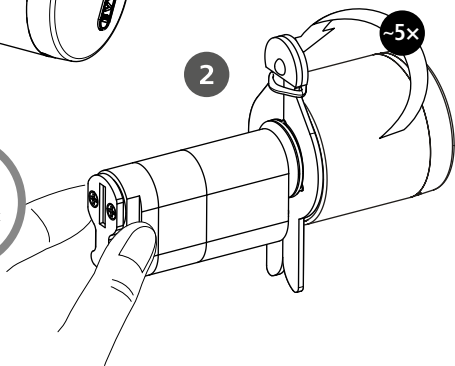
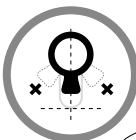

-5x

5

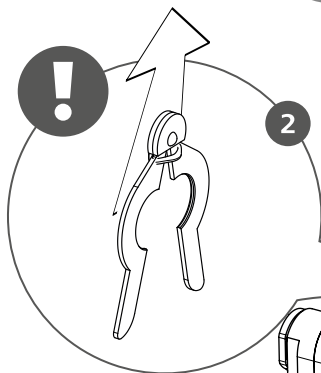

2

1

40°

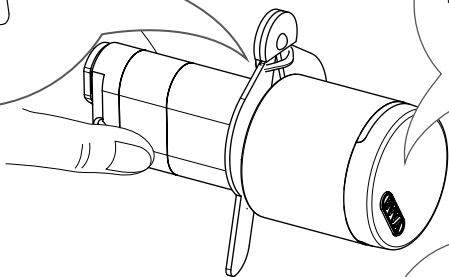

EVVA

!



3

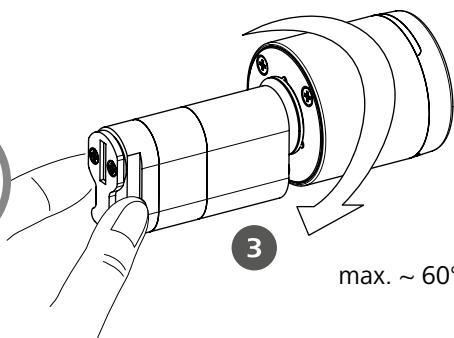

max. ~ 60°



6

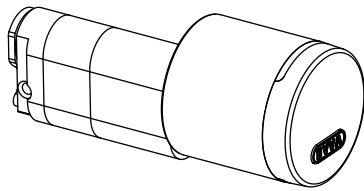

1

AirKey Xesar



2

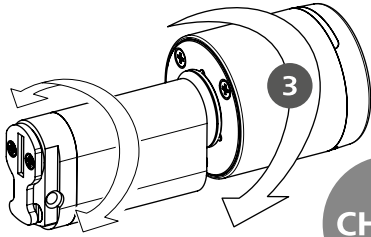
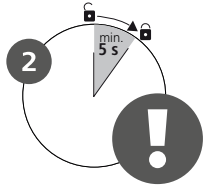

3

CHECK

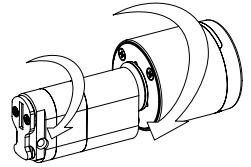
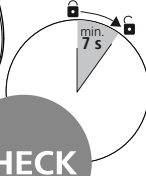

7



2

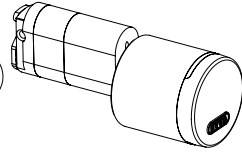
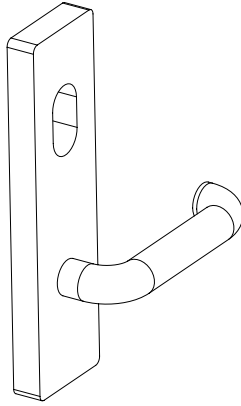
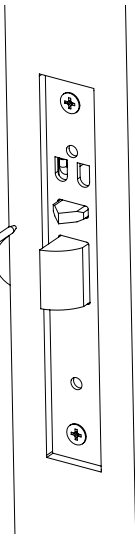

1

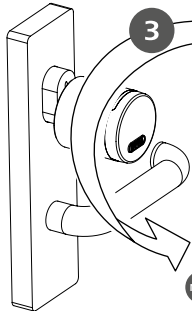
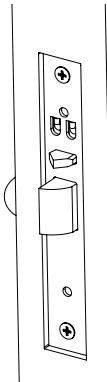

3

AirKey Xesar

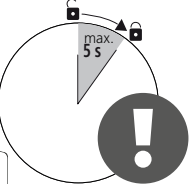
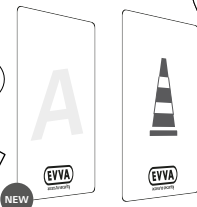

8

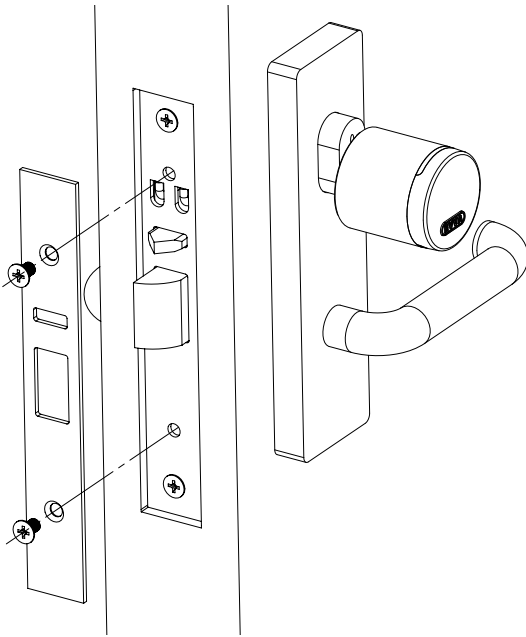
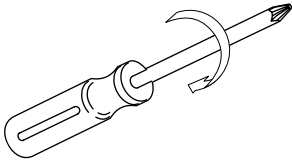

9



CHECK

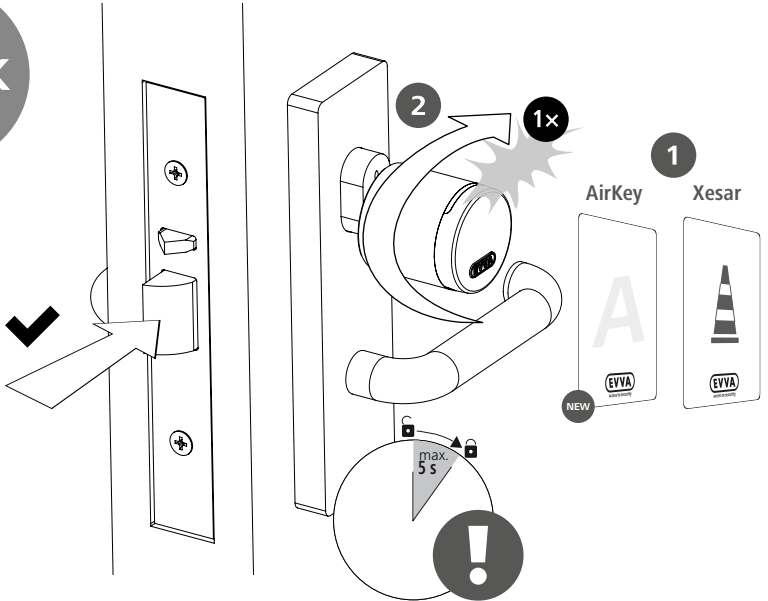

10



Xesar

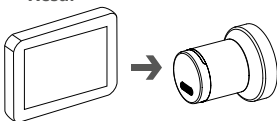

<https://airkey.evva.com>

CE UK UK
NI CA



www.evva.com

EVVA Sicherheitstechnologie GmbH | Wienerbergstraße 59-65 | A-1120 Wien